

Product data sheet

Characteristics

9070T500D3

Transformer, Type T, industrial control, 500 VA,
208 VAC primary / 120 VAC secondary, 1 phase,
50/60 Hz, 115 °C rise



Product availability: Stock - Normally stocked in distribution facility

Price*: 471.00 USD



Main

Product or component type	Industrial Control Transformer
Rated power in VA	500 VA
Range of product	T

Complementary

Phase	1 phase
Rated power in VA	500 VA UL 500 VA CSA 500 VA NOM 300 VA
Temperature rise	115 °C
Electrical connection	Screw clamp terminals
Height	3.84 In (97.54 mm)
Width	4.5 In (114.30 mm)
Depth	5.49 In (139.45 mm)
Material	Copper winding
Product compatibility	FSC2

Environment

Product certifications	CSA file LR37055 guide 184-N-90 UL listed file E61239
NEMA degree of protection	Not rated (open device)
Insulation temperature	356 °F (180 °C)

Ordering and shipping details

Category	16201 - 9070 T (NOT TF) 250-2000VA
Discount Schedule	CP8
GTIN	00785901905677
Nbr. of units in pkg.	1
Package weight(Lbs)	12.55 Lb(US) (5.693 kg)
Returnability	Yes
Country of origin	MX

Packing Units

Unit Type of Package 1	PCE
Package 1 Height	6.40 In (16.256 cm)
Package 1 width	6.80 In (17.272 cm)
Package 1 Length	7.50 In (19.05 cm)

Offer Sustainability

Sustainable offer status	Green Premium product
California proposition 65	WARNING: This product can expose you to chemicals including: Phenyl glycidyl ether, which is known to the State of California to cause cancer and birth defects or other reproductive harm. For more information go to www.P65Warnings.ca.gov
REACH Regulation	REACH Declaration
EU RoHS Directive	Compliant EU RoHS Declaration
Mercury free	Yes
RoHS exemption information	Yes
China RoHS Regulation	China RoHS Declaration
Environmental Disclosure	Product Environmental Profile
PVC free	Yes

Contractual warranty

Warranty	10 Years
----------	----------

Approximate Dimensions

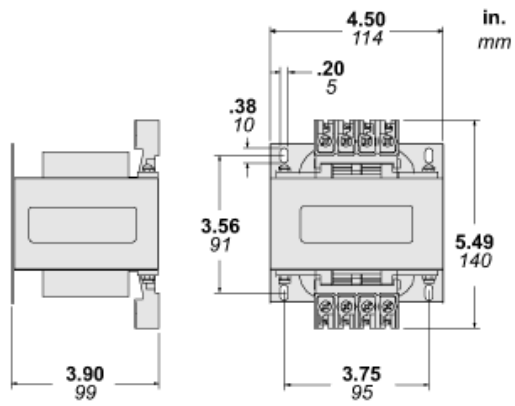

Connections and Wiring Diagrams

Voltage and Connection Options

Voltage Code	Voltages		Connections	
	Primary	Secondary	Primary	Secondary
D3	208	120	Connect to H1 and H2	Connect to X1 and X2
D4	277	120		
D5	550	110		
	575	115		
	600	120		
D6	380	110		
D17	415	110		
D24	110	110		
	115	115		
	120	120		
D93	200	115		
D103	400	120		

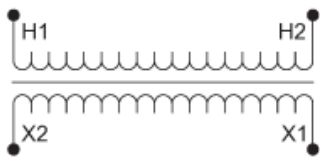

Product Life Status : **Commercialised**